

TRANSITION ADAPTOR PE-BRASS

03 Update - 06/2023

TECHNICAL DATA

Article No	001 117 6200 0090
d (mm)	90
R (inch)	3"
le (mm)	83
Z (mm)	168
s (mm)	8,2
Weight (Kg)	1,410
Box Quantity (pcs)	4
Box Dimension (pcs)	27,5x24x23

INJECTION MOULDED

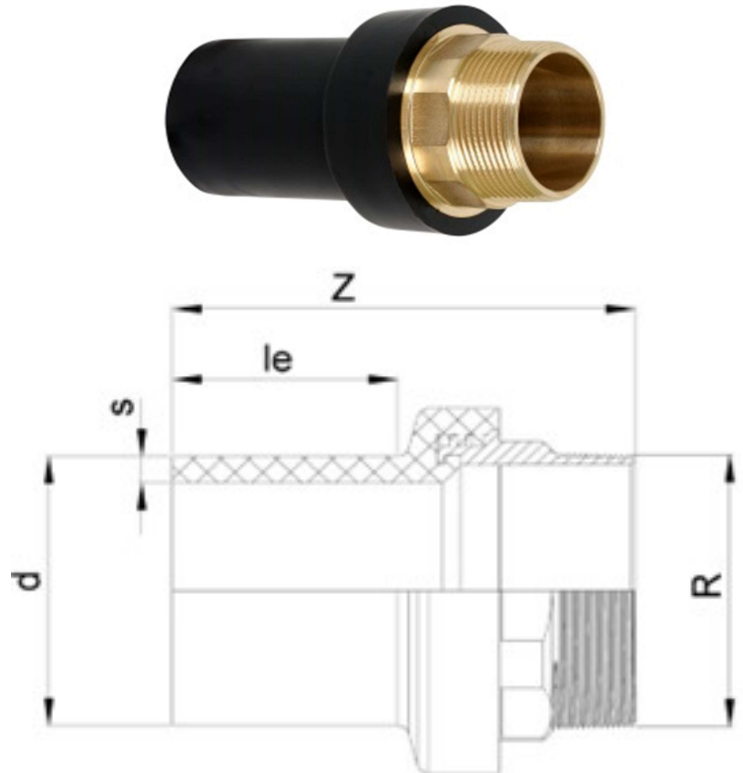

IDENTIFICATION OF PRODUCT

D	90x3"
PN	16
RAW METARIAL	PE 100
PRESSURE CLASS	16 Bar Water
TRADEMARK	NTG
EXECUTION	Injection Moulded
STANDARD	EN 12201-3

SPECIFICATION

Long Spigot

Tolerance on diameters and thickness according to the standards. The other dimensions are specialized. Tolerance $\pm 5\%$. NTG PLASTIK reserves all the right to change any information without giving prior notice. The production, distribution and utilization of this document without explicit authorization is prohibited.